



SPECIFICATIONS

- 40 mil Polyolefin exterior coating
- Sealing boots for conduit
 - No VOC's
 - No Halogens

COATED LIQUID TIGHT CONNECTORS

COMPLIANCES

- UL Standard 514B

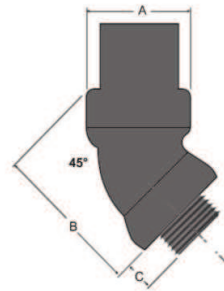
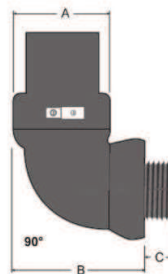
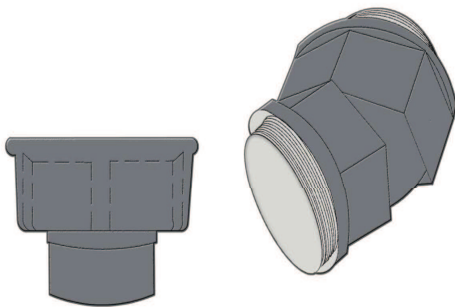
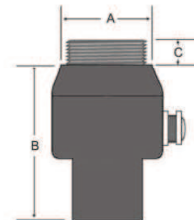
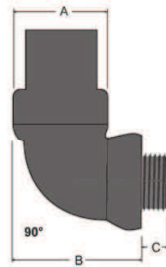
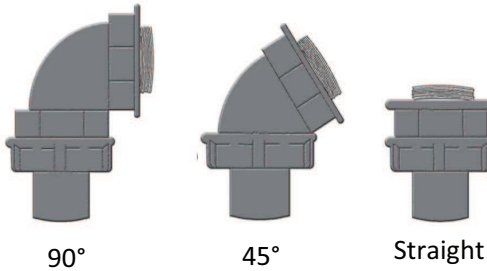
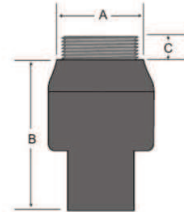
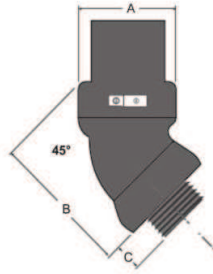
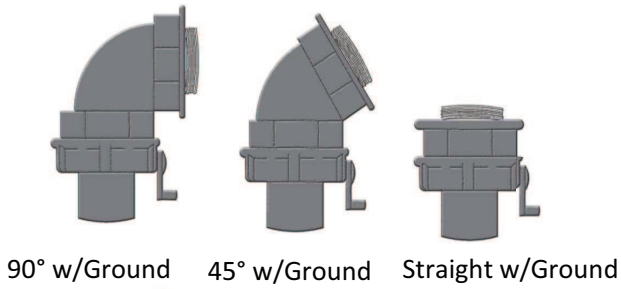

Dimension and Specifications are subject to change without notice



COATED LIQUID TIGHT

LIQUID TIGHT STRAIGHT CONNECTORS					
SIZE	CATALOG #	A	B	C	WT
1/2"	ST50GG	1.24	1.88	0.56	0.2
3/4"	ST75GG	1.46	2.06	0.56	0.2
1"	ST100GG	1.74	2.38	0.56	0.3
1-1/4"	ST125GG	1.96	3.06	0.75	0.4
1-1/2"	ST150GG	2.36	3.75	0.81	0.8
2"	ST200GG	2.8	4.19	0.81	0.9
2-1/2"	ST250GG	3.33	5.06	0.88	1.7
3"	ST300GG	3.83	6.13	1	3
3-1/2"	ST350GG	4.58	6.25	1	4.2
4"	ST400GG	5.58	6.5	1.13	6.2

LIQUID TIGHT 45° CONNECTORS					
SIZE	CATALOG #	A	B	C	WT
1/2"	ST5045GG	1.24	1.88	0.56	0.2
3/4"	ST7545GG	1.46	2.06	0.56	0.2
1"	ST10045GG	1.74	2.38	0.56	0.3
1-1/4"	ST12545GG	1.96	3.06	0.75	0.4
1-1/2"	ST15045GG	2.36	3.75	0.81	0.8
2"	ST20045GG	2.8	4.19	0.81	0.9
2-1/2"	ST25045GG	3.33	5.06	0.88	1.7
3"	ST30045GG	3.83	6.13	1	3
3-1/2"	ST35045GG	4.58	6.25	1	4.2
4"	ST40045GG	5.58	6.5	1.13	6.2

LIQUID TIGHT 90° CONNECTORS					
SIZE	CATALOG #	A	B	C	WT
1/2"	ST5090GG	1.24	1.88	0.56	0.3
3/4"	ST7590GG	1.46	2.06	0.56	0.3
1"	ST10090GG	1.74	2.38	0.56	0.4
1-1/4"	ST12590GG	1.96	3.06	0.75	0.5
1-1/2"	ST15090GG	2.36	3.75	0.81	1.5
2"	ST20090GG	2.8	4.19	0.81	1.7
2-1/2"	ST25090GG	3.33	5.06	0.88	2
3"	ST30090GG	3.83	6.13	1	3
3-1/2"	ST35090GG	4.58	6.25	1	4.2
4"	ST40090GG	5.58	6.5	1.13	6.2

LIQUID TIGHT 90° CONNECTORS W/ GRND					
SIZE	CATALOG #	A	B	C	WT
1/2"	ST5090GGG	1.24	1.8	0.56	0.3
3/4"	ST7590GGG	1.46	2.1	0.56	0.3
1"	ST10090GGG	1.74	2.54	0.56	0.4
1-1/4"	ST12590GGG	1.96	3.23	0.75	0.5
1-1/2"	ST15090GGG	2.36	4.04	0.81	1.5
2"	ST20090GGG	2.8	4.48	0.81	1.7
2-1/2"	ST25090GGG	3.33	5.48	0.88	2
3"	ST30090GGG	3.83	10.92	1	3
3-1/2"	ST35090GGG	4.58	12.29	1	4.2
4"	ST40090GGG	5.58	14.68	1.13	6.2

LIQUID TIGHT STRAIGHT CONNECTORS W/ GRND					
SIZE	CATALOG #	A	B	C	WT
1/2"	ST50GGG	1.24	1.88	0.56	0.2
3/4"	ST75GGG	1.46	2.06	0.56	0.2
1"	ST100GGG	1.74	2.38	0.56	0.3
1-1/4"	ST125GGG	1.96	3.06	0.75	0.4
1-1/2"	ST150GGG	2.36	3.75	0.81	0.8
2"	ST200GGG	2.8	4.19	0.81	0.9
2-1/2"	ST250GGG	3.33	5.06	0.88	1.7
3"	ST300GGG	3.83	6.13	1	3
3-1/2"	ST350GGG	4.58	6.25	1	4.2
4"	ST400GGG	5.58	6.5	1.13	6.2

LIQUID TIGHT 45° CONNECTORS W/ GRND					
SIZE	CATALOG #	A	B	C	WT
1/2"	ST5045GGG	1.24	1.94	0.56	0.3
3/4"	ST7545GGG	1.46	2.38	0.56	0.3
1"	ST10045GGG	1.74	2.88	0.56	0.4
1-1/4"	ST12545GGG	1.96	3.25	0.75	0.5
1-1/2"	ST15045GGG	2.36	4	0.81	1.5
2"	ST20045GGG	2.8	4.88	0.81	1.7
2-1/2"	ST25045GGG	3.33	5.88	0.88	2
3"	ST30045GGG	3.83	6.25	1	3
3-1/2"	ST35045GGG	4.58	6.25	1	4.2
4"	ST40045GGG	5.58	6.63	1.13	6.2

Dimension and Specifications are subject to change without notice